

GE Healthcare

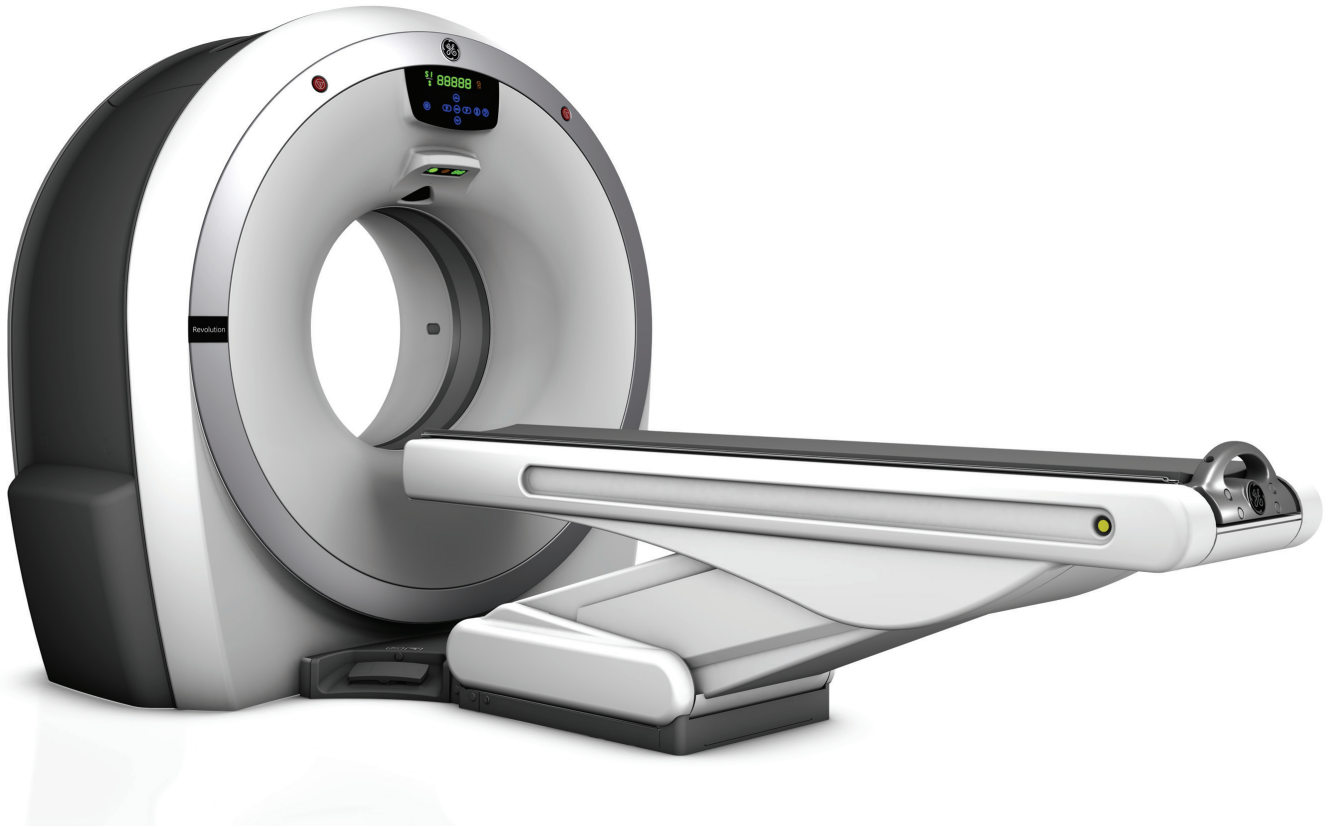

Revolution ACT

Your Aspirations. Realized.

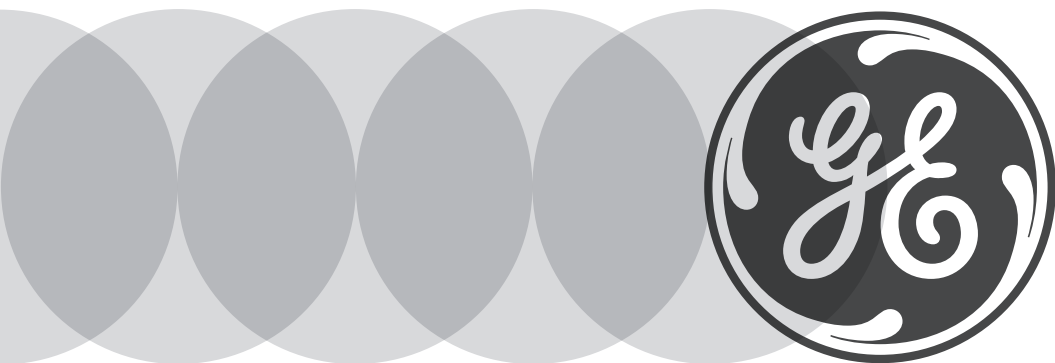



Revolution. Redefine what's possible with CT.

Millions of patients around the world are still waiting to receive the standard of care they need and in an affordable way. Healthcare providers are seeking better technology to help more patients and drive better outcomes.

Simple and fast, CT is arguably the most valuable diagnostic imaging tool in healthcare. Yet its capacity to improve patient health is far from tapped.

The Revolution™ family of CT scanners helps you redefine what's possible

with CT. Designed with your needs in mind, each Revolution product in the family is designed to deliver four key benefits: diagnostic confidence, patient care, financial performance and clinical excellence.

All revolutions start somewhere. Our revolution began with the Revolution CT system — designed from the ground up for pioneering the future of CT.

**Now comes
Revolution ACT.**

Your Aspirations. Realized.

Healthcare today offers new opportunities for growth, and the quality of CT imaging services can make all the difference in what you're able to achieve.

A Revolutionary concept

Revolution ACT is designed not only as a product, but as a solution to help you provide better patient care — and provide access to more patients. It's the centerpiece of our commitment to help you achieve your CT imaging services aims.

You'll find many of the technologies inherited from our most advanced Revolution CT system — like the new Clarity panel detector, new user interface, or Organ Dose Modulation.

Helping you feel more confident about moving to the next level, clinically and economically — that's intelligent innovation.

We're with you all the way

Offer the CT imaging services that are most attractive to your physicians and patients, do it most efficiently, and grow your value with the full support of GE Healthcare education, training, and uptime services.

Revolution ACT: It's exactly what's needed to help you achieve success. And exactly what you'd expect from GE.





“Our goal is sustainable growth.”

All businesses depend on sustainable growth, either by deepening relationships with current customers or attracting new ones – or both. Capture new opportunities by offering referring physicians and patients higher levels of clinical results while maintaining a stable economic foundation.

Investment security

Protect your investment by choosing the latest technology platform. Revolution ACT features a host of modern innovations such as the new Clarity panel detector. A complete product designed for better ROI and quick break-even.

Engineered for lower operating costs

Benefit from a proven compact geometry platform that has a small footprint to ease siting and installation. A new compact generator helps reduce power consumption over time.

Expand your clinical reach

Revolution ACT provides the essential tools and advanced clinical applications needed as you grow your referral network to support the routinely scheduled scans to the unexpected trauma, stroke, or vascular scans.

Stay up and running

Benefit from the support of a large and experienced network of GE Healthcare field and online service engineers. Our global and local supply chain helps to ensure the highest quality spare parts are readily available should you need them.



“We want to offer more services while still managing costs.”

Improve your ability to provide CT scan services while managing the overall cost of care. Revolution ACT can help you reach more patients and enables them to benefit from a range of care that includes CT while they're there, 24/7.

Do more for more patients

Increase your ability to image a wide variety of inpatients. Revolution ACT features and functions are tuned to serve every patient – from emergency and trauma to pediatric and from the elderly to larger sized patients.

Ready when you are

Be prepared at all times with innovations like a power management system that cuts detector warm up time. Once patients arrive, our intelligent workflow with many automated tools helps you achieve efficiency and higher throughput.

Reduce workflow variability

Increasing consistency can help reduce costs, too. Every hospital is distinct and has specific needs – and innovative technologies like Digital Tilt, Emergency Scan Mode, and Spectral Calibration can help you achieve consistent workflow outcome.



“We want to provide a more informed diagnosis.”

Patients are counting on you. Count on Revolution ACT to help enhance your reputation for clinical excellence. It's purposely designed to help you deliver higher quality results with more consistency and speed.

Impact patient care more profoundly

You'll clearly see more with the new Clarity panel detector design that delivers a spatial resolution of 18 lp/cm. And Revolution CT-based electronics with DAS on Detector (DoD) helps lower noise by 20% for better image quality.

Manage radiation dose

Provide dose-conscious care to your patient with ASiR - our iterative reconstruction technology that can lower dose up to 40% at comparable image quality. Smart Dose gives you access to an array of dose reduction technologies for pediatric to the elderly and high BMI patients.

More anatomical detail and clinical confidence

Technologies like ultra-kernel with sub-millimeter imaging gives you sharp high resolution images to see anatomical structures in detail and clarity. Designed to support your advanced studies with Smart Prep and dynamic transition along with applications such as Auto bone Xpress and Vessel IQ.

Technologies that revolve around you

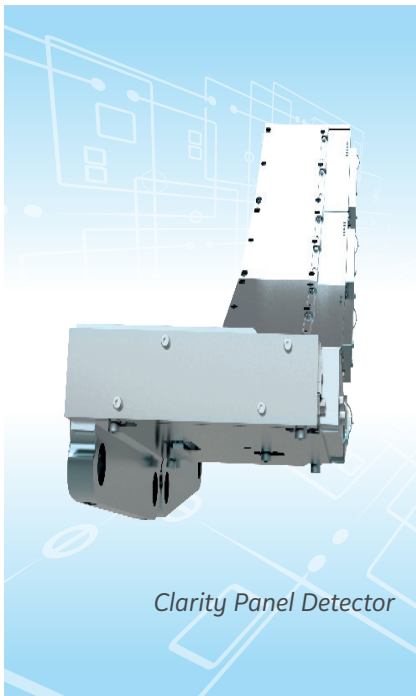

Designed with your needs in mind, Revolution ACT helps you improve standards of patient care by providing new levels of Image quality, patient safety, economic value, and advanced applications. Powering these advances is a host of integrated, largely exclusive technologies.

Higher Performance - Modern Detector Design

Clarity panel detector: An innovative detector technology is an industry first to introduce a segmented panel design with many design elements inherited from our premium Revolution CT.

Improved spatial resolution

Clarity panel detector delivers exceptional spatial resolution of 18 lp/cm to enable high quality imaging and visualization of anatomy in 3D.

Up to 20% lower electronic noise

An integrated detector design built with modern chipsets and DAS on detector (DoD) technology used in our premium Revolution CT to lower noise and achieve high signal to noise performance.

Low power efficient design

A compact and power efficient design, each detector module consumes a paltry 2mW per channel. Intelligent thermal management is tightly integrated within the detector so it is ready to scan within minutes.

Higher Performance -improved imaging chain

Ultra Kernel

Adaptive Enhance Level Adjustment (AELA) can improve visual spatial resolution while maintaining pixel noise standard deviation. This kernel may be helpful in enhancing the visualization of small anatomical structures with high contrast.

Advanced Acquisition

A higher sampling density provides better representation of the original signal and can potentially lead to improved image quality and fidelity. Using GE's novel conjugate cone beam reconstruction algorithm, the conjugated rows of projections are considered jointly in the back projection step and delivers improved Z-axis visualization performance.

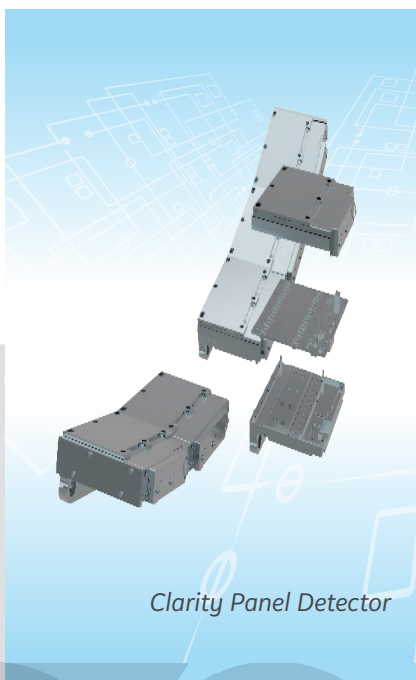

Clinical excellence everyday

Sinus exam

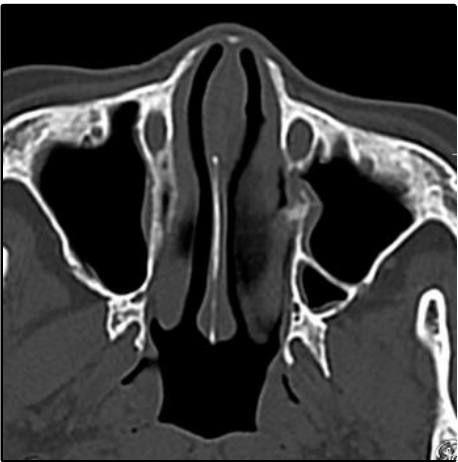

Helical, 0.562:1, 120kV, 160-170mA, 1.25mm,
Bone, ASIR 30%, 0.1 msv

C-Spine exam

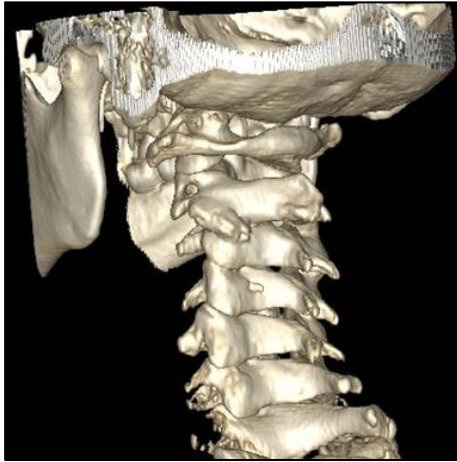

Helical, 0.938:1, 120kV, 120-200mA, 1.25mm,
Standard, Bone+, ASIR50%, 1.6 msv

Standard

Bone+

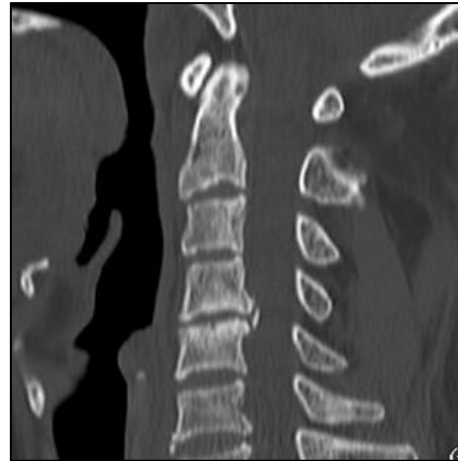

Abdominal multiphase exam



Pre-contrast



1st phase

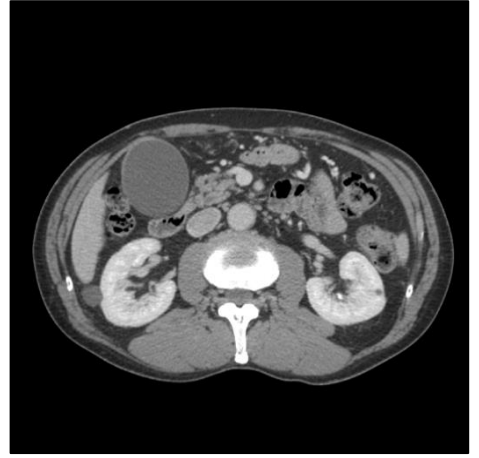

2nd phase

Helical, 1.375:1, 120kV, 114-169mA, 5mm,
1.25mm, Standard

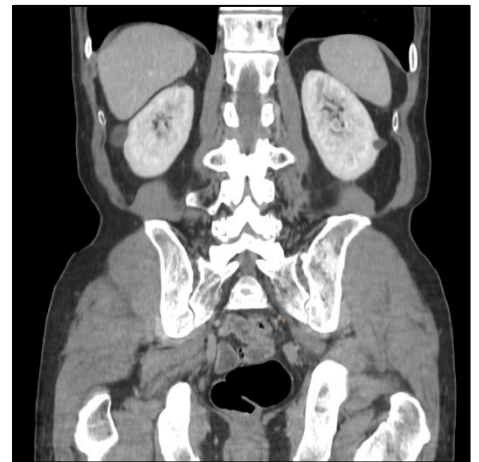

2nd phase

Lung cancer screening exam



Helical, 1.375:1, 120kV, 180-200mA, 1.25mm,
Standard, ASIR 30%

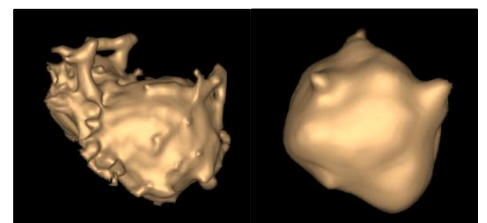
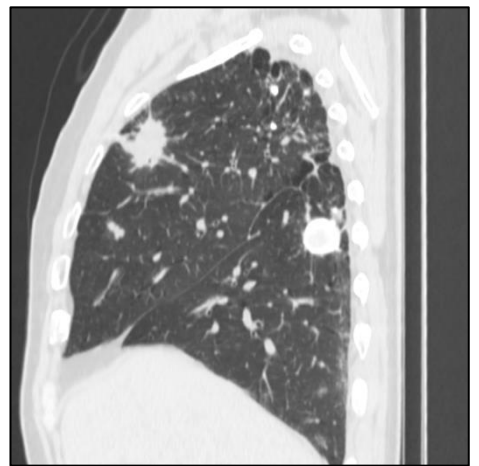

Shoulder exam

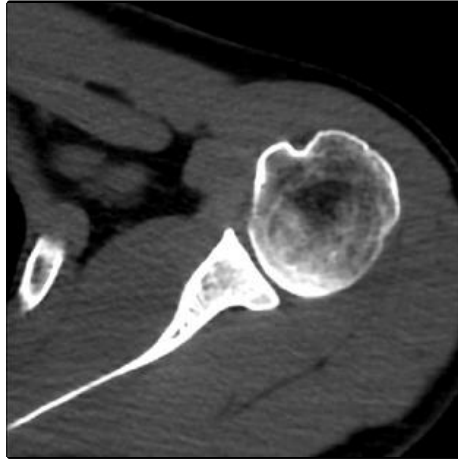

Helical, 0.938:1, 120kV, 71-127mA, 1.25mm,
Standard, Bone+, ASIR30%, 2.9mSv

Standard

Bone+

Foot exam

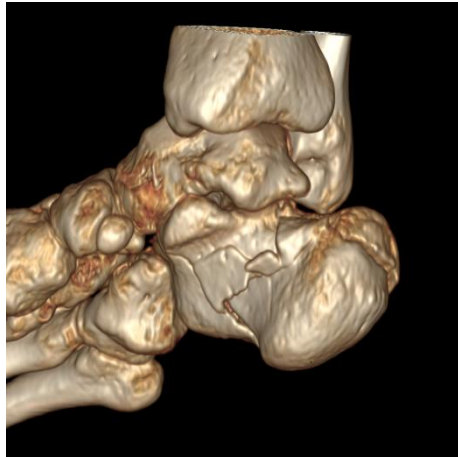
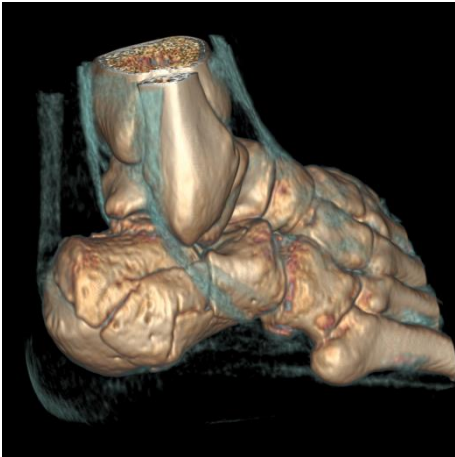

Helical, 0.875:1, 120kV, 100mA, 1.25mm, Bone+,
ASIR 30%, 40%, 1.4mSv

Hip exam

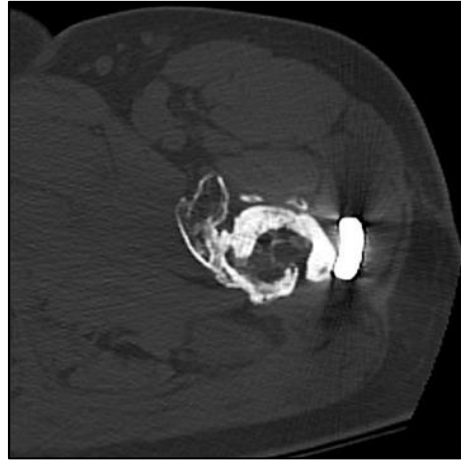
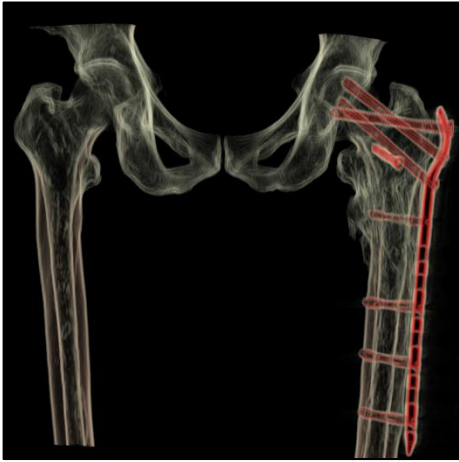

Helical, 0.625:1, 120kV, 110mA, 1.25mm, Bone+, ASIR 30%, 9.3mSv

Wrist exam

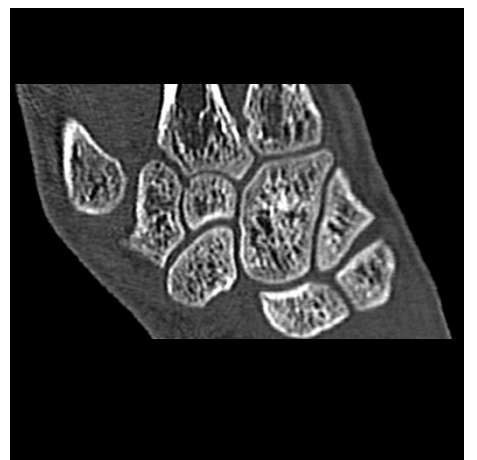
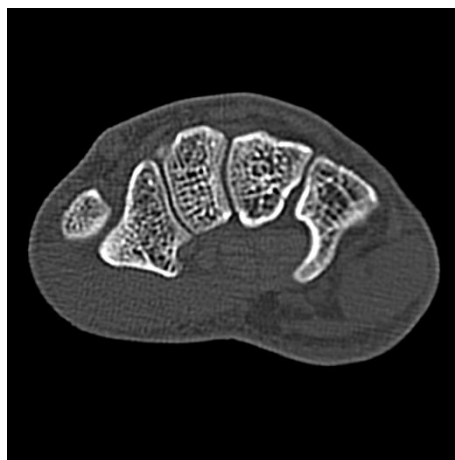
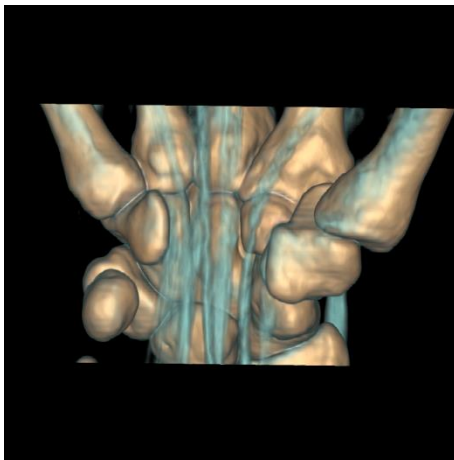

Helical, 0.938:1, 120kV, 100mA, 0.625mm, Ultra, ASIR30%, 0.63mSv

Ultra, edge 2

Ultra, edge 2

Smart Dose Technologies

Intelligent technology designed to help you acquire high-quality images using lower doses of radiation, contributing to more accurate diagnoses and lower exposures for patients.

ASiR™ Image quality at significantly lower dose

- ASiR is an advanced iterative reconstruction technique that provides breakthrough image quality in multi-slice CT exams at significantly less dose than before. It allows healthcare providers to lower dose by up to 40% to your patients as compared to standard image reconstruction without reducing imaging quality.
- ASiR uses sophisticated statistical modeling to remove noise in images while preserving anatomical detail. It improves low-contrast detectability and can have equivalent IQ to an acquisition with 1.67 times the mA.
- The maximum tube power and current of ASiR allows achieving the same image quality at a lower mA with less tube heat output, which enables the tube for longer duration under helical scan.
- Revolution ACT performance will be equivalent to 40KW and 333mA(@120kV, 3.3MHU tube heat capacity equivalence with ASiR). This improved efficiency helps lower power consumption and operational costs to the administrators.

Smart Dose Technologies

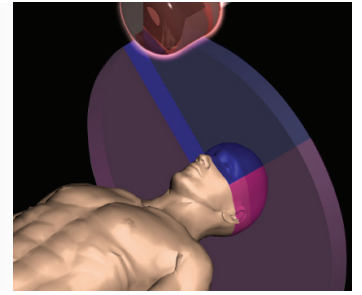

Volumetric Image Space Reconstruction (ViSR*): An advanced filter helps manage photon starvation in large-size patients as well as wide or dense anatomical objects such as shoulders and pelvis. A 3D filter reduces noise without compromising resolution, for clear visualization of brain, tumor, and pediatric cases. ViSR delivers up to a 20% improvement in image quality at the same dose, or the same image quality with up to a 36% dose reduction.

Organ Dose Modulation (ODM): ODM was developed to act as a virtual shield and provide the dose reduction goal of a shield material without the negative effects it may have on imaging performance. Reduce radiation dose up to 40% when imaging superficial tissues like breasts and eyes through ODM.

Dose Check: Receiving notifications and alerts if your predetermined dose levels will be exceeded enables you to correct and confirm the right settings before scanning to avoid unnecessary radiation dose to your patient.

3D mA Modulation: Feature enables the system to optimize tube current in x-y-z directions with negligible effect on image quality. The system varies mA according to patient shape and scan protocol to lower dose in a patient-centric manner.

DoseWatch™: A comprehensive dose management solution. Keep dose levels as low as reasonably achievable (ALARA) while producing sharp, focused diagnostic images. Track and monitor patients' cumulative radiation dose over time and take steps to prevent excessive radiation dose.

Work smarter

Smart Flow Technologies

Systems designed to help you improve productivity by streamlining user workflow and access to information.



- Digital Tilt:** This advancement in image reconstruction technology enables you to scan patients more efficiently — up to 28% in routine scan workflow. The entire workflow is easy to setup and control from the CT console. Simpler and faster, digital tilt helps you manage the challenging and less cooperative patients, while completing the scan with the quality you need.
- Spectral Calibration:** See an improvement in image uniformity in off-centered scans using a unique technology for beam hardening correction that makes patient positioning and setup more robust to operator variability.
- IQ Enhance:** This advanced algorithm enables helical pitch acceleration up to 2.7x while still achieving the same image quality as a conventional scan. Completing scans faster helps your patients breathe easier with shorter breath hold time.
- User Console:** Inspired by our most premium product, Revolution CT, the console for Revolution ACT has been designed to make it easy to learn and use. Its modern look and feel is created from insights obtained from a wide cross section of radiologists and technologists.

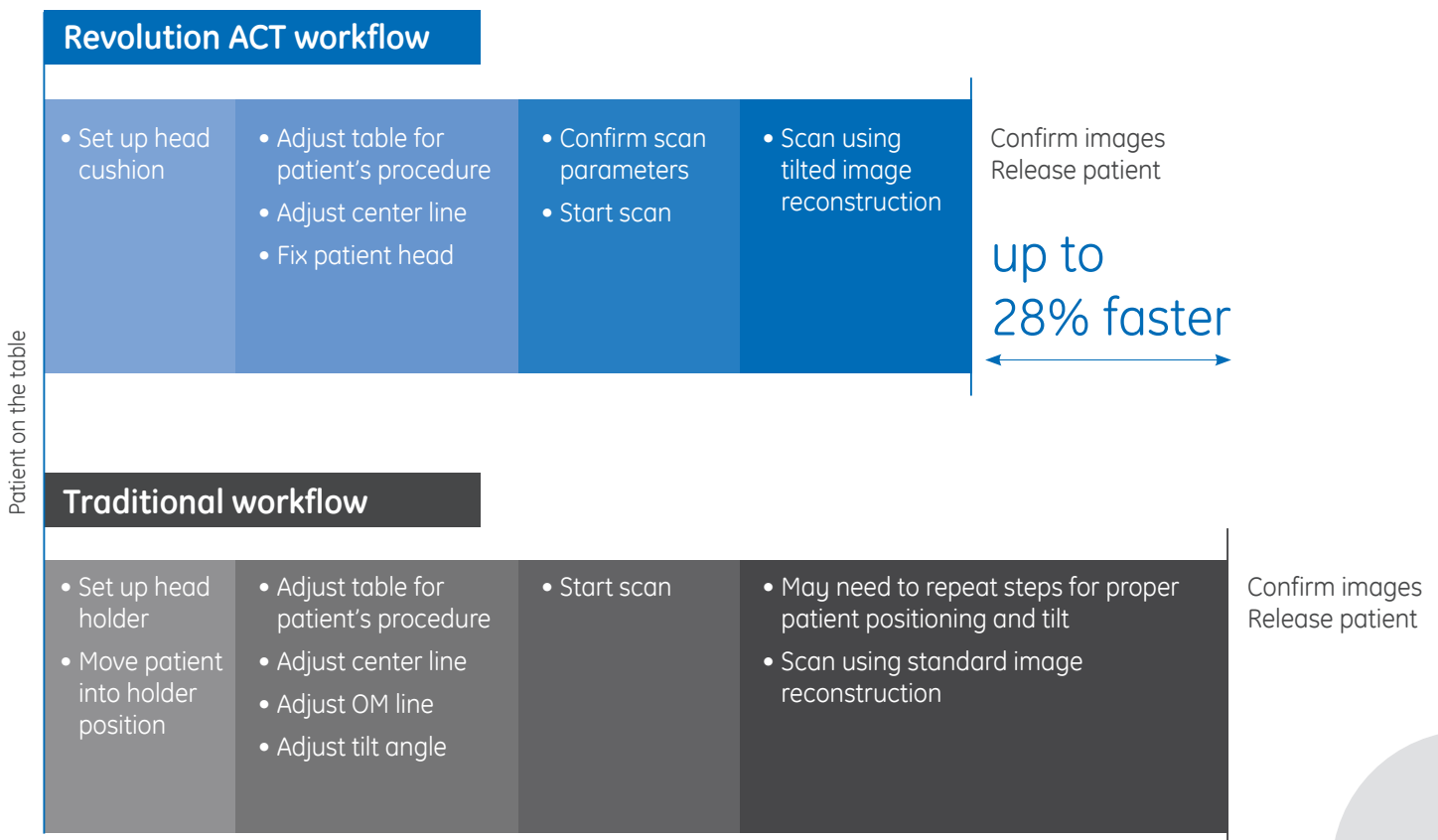

* Actual results may vary depending on the circumstances, including but not limited to, exam type, clinical practice, and image reconstruction technique. This information was based on a simulation using the GE Revolution ACT device and is presented for illustrative purposes only.

Essential and advanced applications

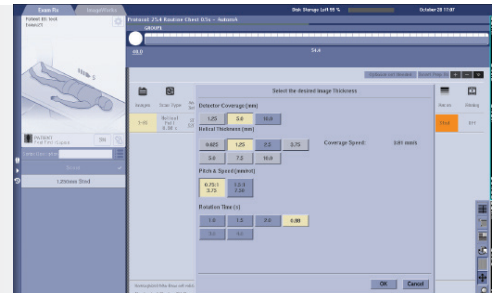

- **Volume Viewer:** Harness the power of Volume Viewer to make 3D visualization routine. Get more information about the spatial relationships of different structures using multi-object volume rendering, multi-planar reformat, and MIP/min-MIP.
- **Navigation and Fly-Through:** Use Virtual Endoscopy to visualize intra-luminal structures such as airways, sinuses, or vascular structures. A virtual “fly-through” mode lets you view images dynamically.
- **SmartPrep with Dynamic Transition:** SmartPrep allows intermittent monitoring of IV contrast enhancement in an area of interest using low-dose scan. Dynamic transition provides automatic transition from monitor phase to scan phase.
- **Vascular Imaging and Processing:** Allows enhanced analysis of vascular features by automatically determining vessel centerline and tracking multiple vessels. You can also view oblique cross sections of vascular images, and rotate curved views to more clearly visualize vascular lesions.
- **CT Colonography:** Provides quick, accurate, non-invasive colon exams. Prone and supine view can be displayed and synchronized together. You can even conduct a 3D fly-through that resembles an optical colonoscopy. Bookmarking tools mark polyp location, and distance and ROI tools quantify size and homogeneity.
- **DentaScan:** Creates a comprehensive set of cross-referenced composite axial, panorex, and oblique planar reformations of the mandible and/or maxilla. DentaScan gives you the information you need to plan dental implants or orthodontic surgery.
- **CT Perfusion 4D - Multi organ CT Perfusion 4D** - Multi-organs is an image analysis software package that allows the evaluation of dynamic CT data following an injection of a compact bolus of contrast material, and generating information regarding changes in image intensity over time.



A world of support

When we created Revolution ACT, we thought as much about helping you get the most out of it as we did about the technologies that went into it.

For your peace of mind

Revolution ACT has a footprint of only 8.0 m² lowering siting space needed. A low power input requirement of only 40 kVA makes installation simpler and lowers power consumption.

In addition to user training and applications education, count on GE Healthcare to support you with a large and experienced team of field service engineers to help increase your system uptime and access.

Your Revolution ACT scanner features a broadband connection capability with built-in self-check systems to connect your CT scanner directly to our technical centers. So GE service engineers can quickly assess any problem. Often they can fix your system remotely.

Easy to Site

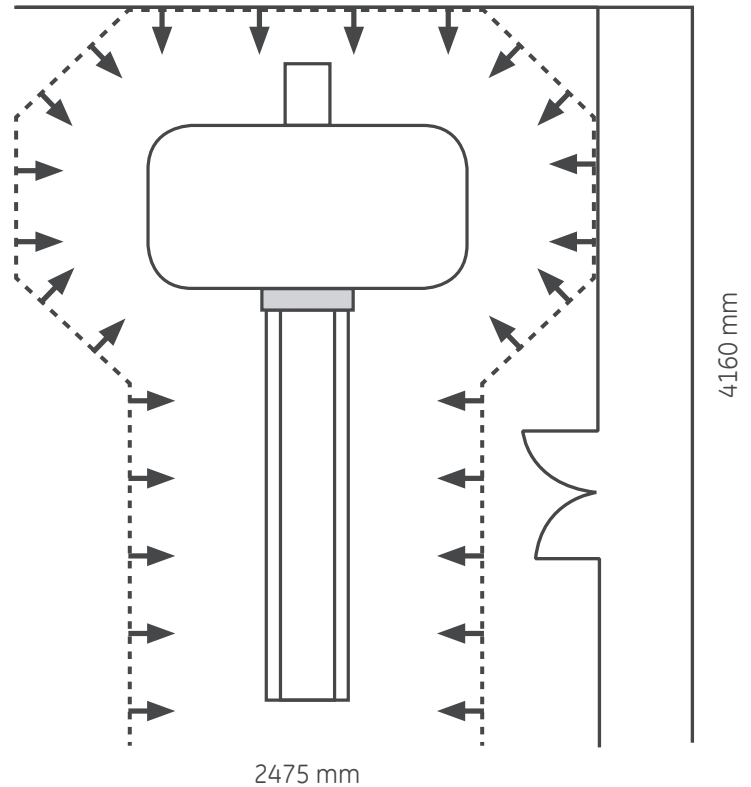

What are your aspirations?

In the end, Revolution ACT is about helping you provide better patient care to more patients in an affordable way. Revolution ACT is designed in a way that reduces the typical tradeoffs you face between quality and affordability. Revolution ACT gives you investment security by opening the door to a host of modern technologies; a more informed diagnosis with higher image quality and wider array of clinical applications; and a patient centric workflow and dose management.

Since physicians began scanning patients with GE CT systems in 1976, few companies can point to the same number of advances to help healthcare providers take better care of their patients and do it more economically.

Your reputation depends on making the right choices. Ours depends on helping you make them.

Contact your GE sales representative to learn more.

Call us now on our toll-free number **1-800-209-9003** or write to us at **teamgehc@ge.com**





www.gehealthcare.com

GE Healthcare provides transformational medical technologies and services to meet the demand for increased access, enhanced quality and more affordable healthcare around the world. GE (NYSE:GE) works on things that matter - great people and technologies taking on tough challenges. From medical imaging, software & IT, patient monitoring and diagnostics to drug discovery, biopharmaceutical manufacturing technologies and performance improvement solutions, GE Healthcare helps medical professionals deliver great healthcare to their patients.

Imagination at work

Wipro GE Healthcare
No. 4, Kadugodi Industrial Area
Bangalore - 560 067, Karnataka
India

© 2015 General Electric Company - all rights reserved

General Electric Company reserves the right to make changes in specifications and features shown herein, or discontinue the product described at any time without notice or obligation.

GE, GE monogram, Imagination at work, Revolution and DoseWatch are trademarks of General Electric Company.

GE Healthcare, a division of General Electric Company.

JB28458XX

Revolution ACT has not been submitted to, approved or cleared by the US FDA. Not for sale in the US.